

CHAPTER 1 RULES OF THE ROAD

DIAGRAM 1

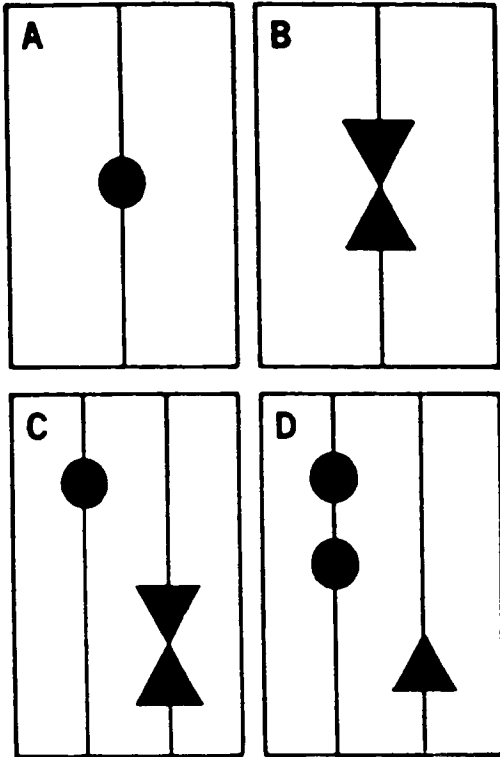

DIAGRAM 2

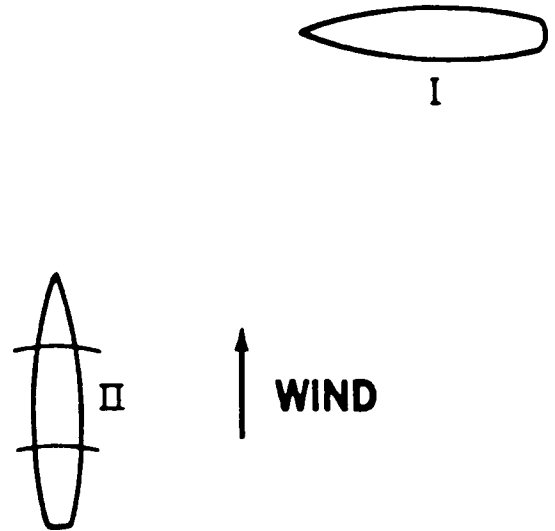

DIAGRAM 3

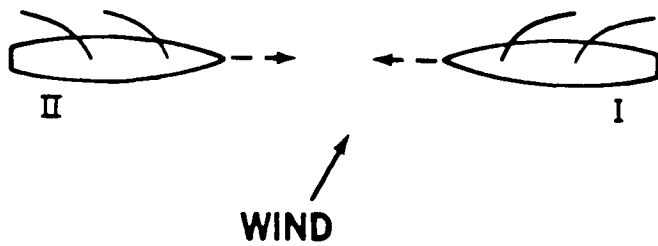

DIAGRAM 4

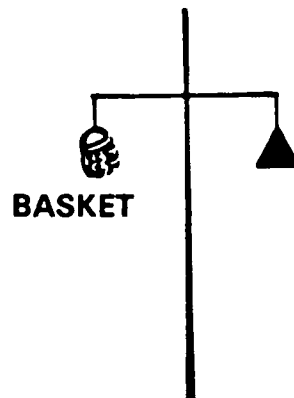

DIAGRAM 5

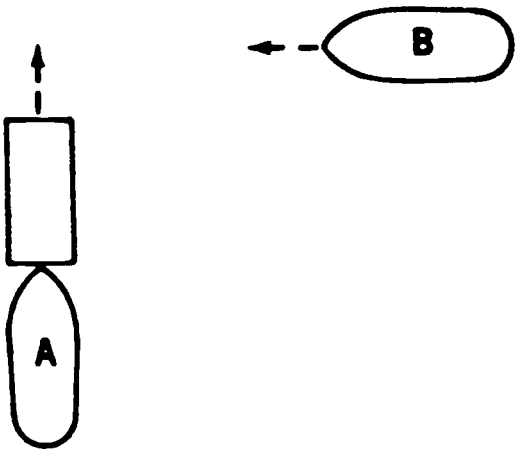

DIAGRAM 6



DIAGRAM 7



DIAGRAM 8

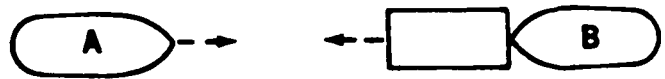

DIAGRAM 9

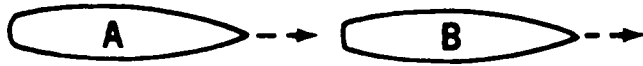

DIAGRAM 10



DIAGRAM 11



DIAGRAM 12

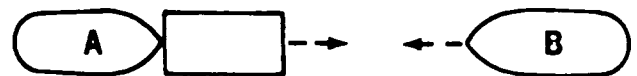

DIAGRAM 13



DIAGRAM 14

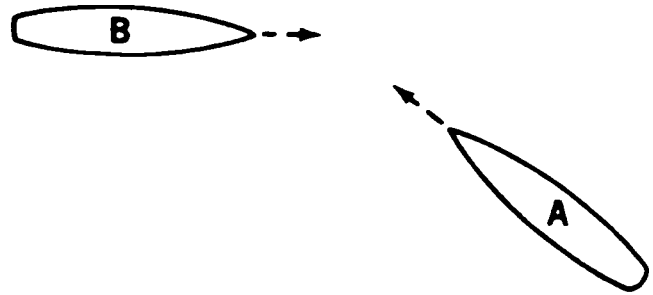

DIAGRAM 15

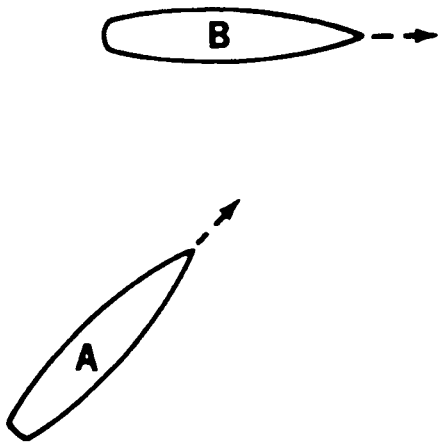

DIAGRAM 16

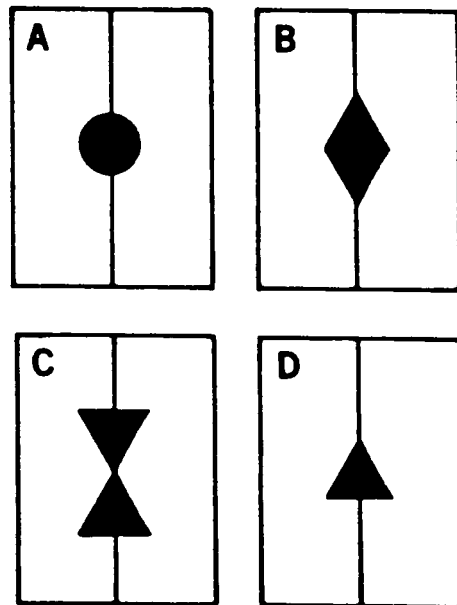

DIAGRAM 17

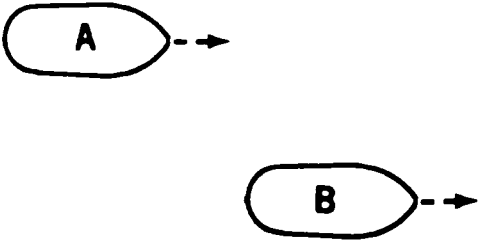

DIAGRAM 18

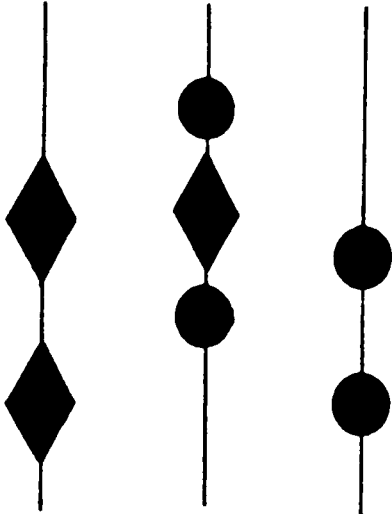

DIAGRAM 19

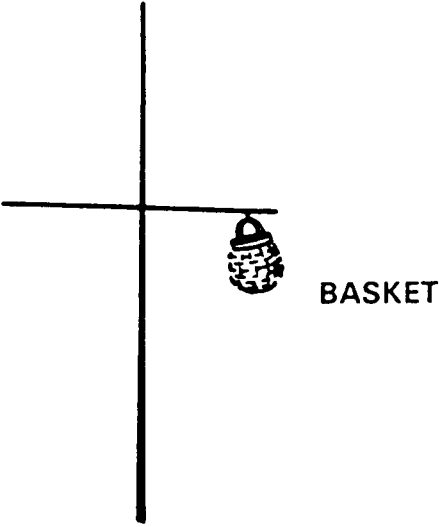

DIAGRAM 20

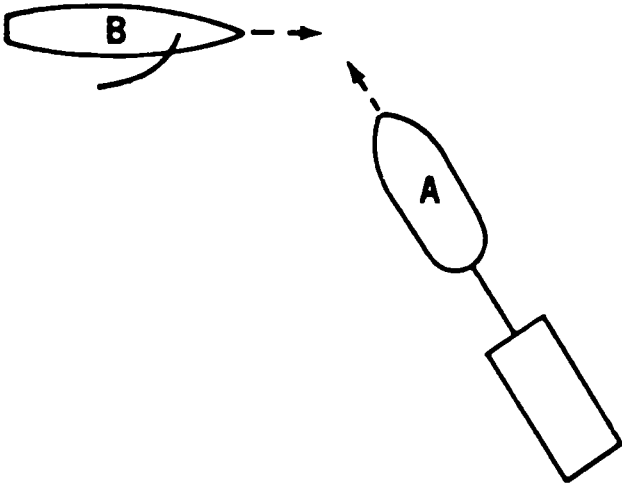

DIAGRAM 21

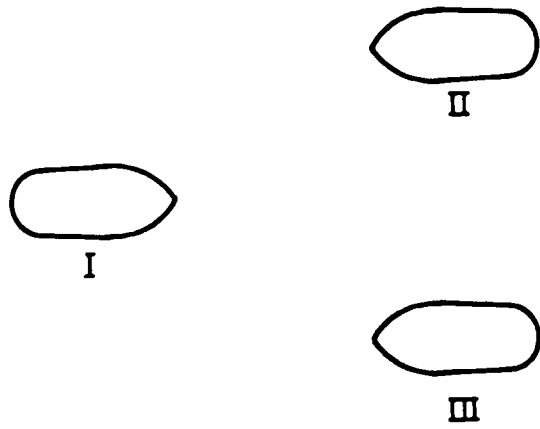

DIAGRAM 22

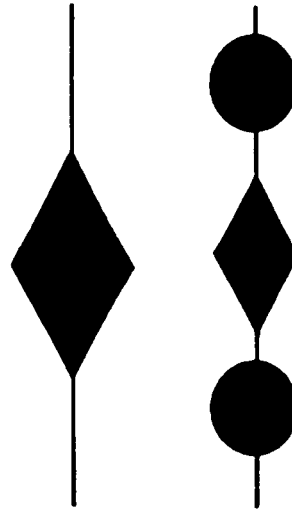

DIAGRAM 23

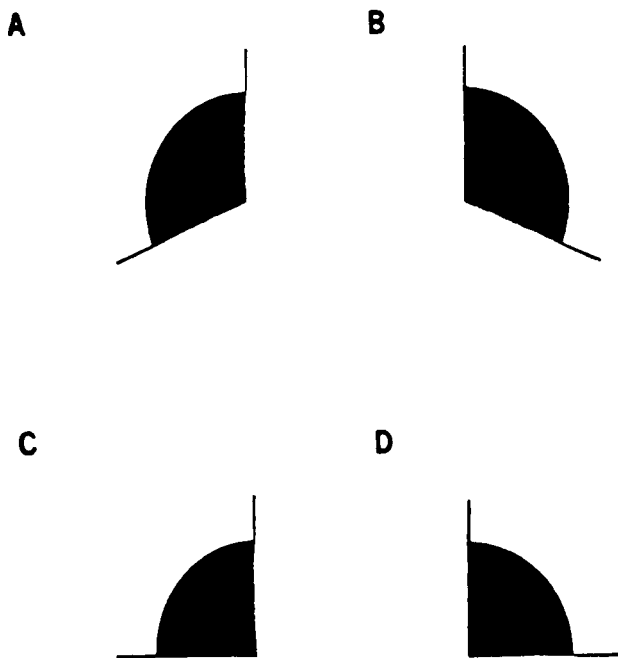

DIAGRAM 24



DIAGRAM 25



DIAGRAM 26



DIAGRAM 27

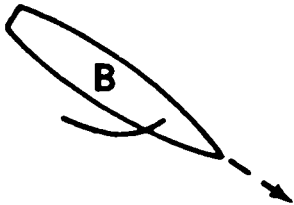

DIAGRAM 28

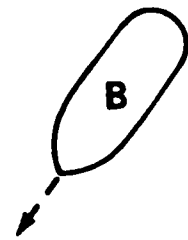

DIAGRAM 29

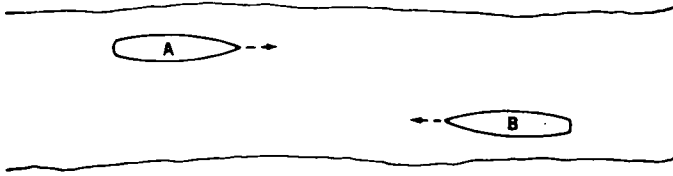

DIAGRAM 30

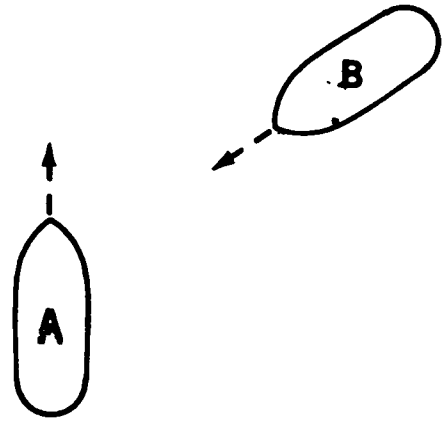

DIAGRAM 31

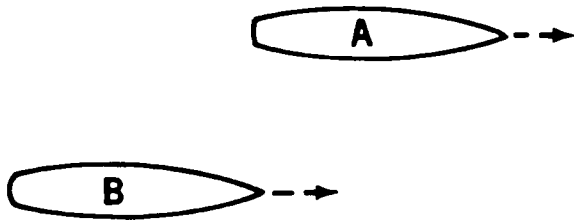

DIAGRAM 32



DIAGRAM 33

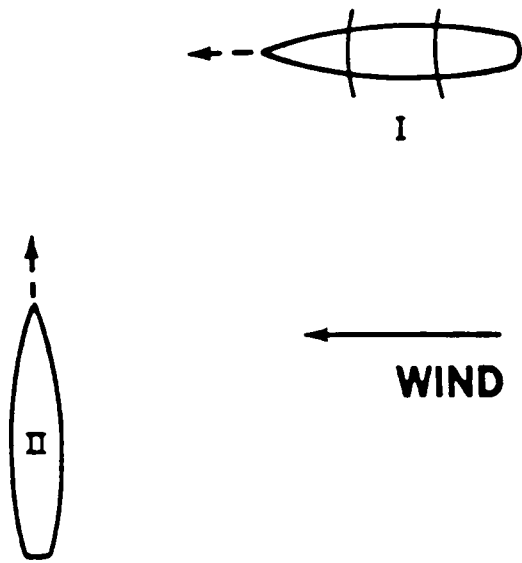

DIAGRAM 34



DIAGRAM 35



DIAGRAM 36



DIAGRAM 37

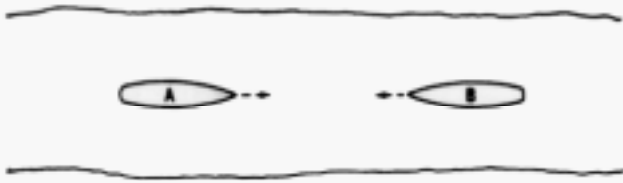

DIAGRAM 38

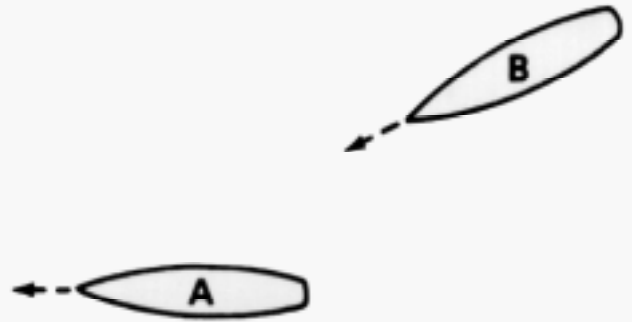

DIAGRAM 39

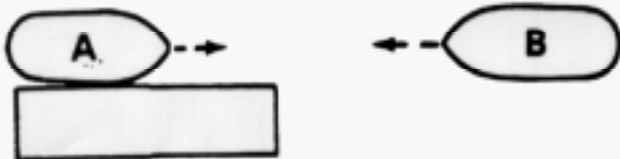

DIAGRAM 40

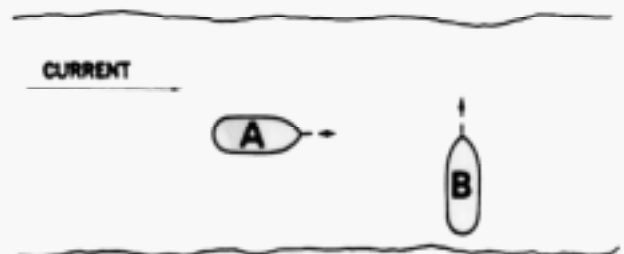

DIAGRAM 41

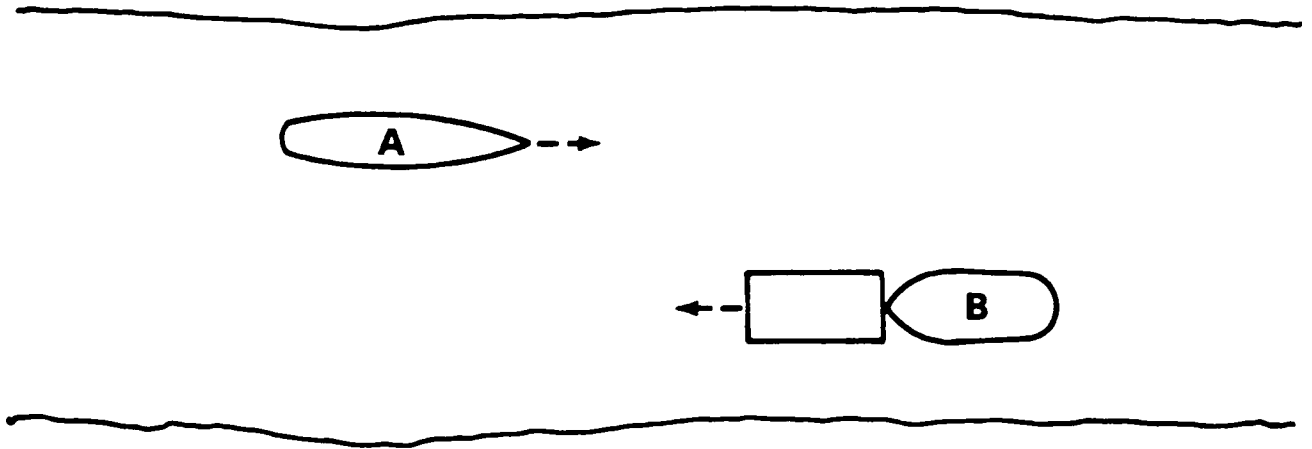

DIAGRAM 42

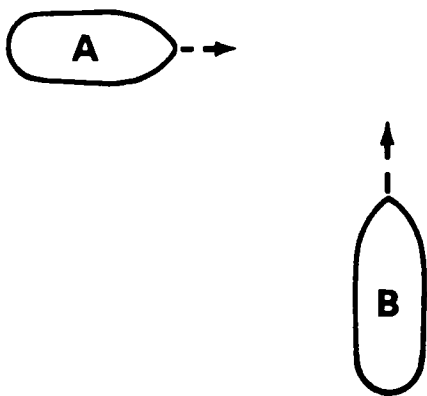

DIAGRAM 43

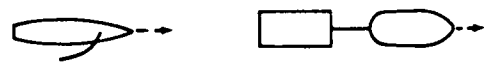

DIAGRAM 44



DIAGRAM 45



DIAGRAM 46



DIAGRAM 47

